

## Isolation and expression in transgenic tobacco and rice plants, of the cassava vein mosaic virus (CVMV) promoter

Bertrand Verdaguer, Alexandre de Kochko, Roger N. Beachy & Claude Fauquet\*  
International Laboratory for Tropical Agricultural Biotechnology (ILTAB/ORSTOM-TSRI), Division of Plant Biology - MRC7, The Scripps Research Institute, 10666 North Torrey Pines Road, La Jolla, CA 92037, USA  
(\*author for correspondence)

Received 12 December 1995; accepted in revised form 16 April 1996

**Key words:** cassava, caulimovirus, CVMV, GUS fusion, promoter, transgenic plants

### Abstract

The cassava vein mosaic virus (CVMV) is a double stranded DNA virus which infects cassava plants (*Manihot esculenta* Crantz) and has been characterized as a plant pararetrovirus belonging to the caulimovirus subgroup. Two DNA fragments, CVP1 of 388 nucleotides from position -368 to +20 and CVP2 of 511 nucleotides from position -443 to +72, were isolated from the viral genome and fused to the *uidA* reporter gene to test promoter expression. The transcription start site of the viral promoter was determined using RNA isolated from transgenic plants containing the CVMV promoter:*uidA* fusion gene. Both promoter fragments were able to cause high levels of gene expression in protoplasts isolated from cassava and tobacco cell suspensions. The expression pattern of the CVMV promoters was analyzed in transgenic tobacco and rice plants, and revealed that the GUS staining pattern was similar for each construct and in both plants. The two promoter fragments were active in all plant organs tested and in a variety of cell types, suggesting a near constitutive pattern of expression. In both tobacco and rice plants, GUS activity was highest in vascular elements, in leaf mesophyll cells, and in root tips.

### Introduction

The cassava vein mosaic virus (CVMV) infects cassava plants in north-eastern regions of Brazil. Infected plants develop chlorosis along the veins which evolves later into a mosaic pattern. The circular double stranded DNA genome of the CVMV is encapsidated in 50–60 nm isometric particles which accumulate in inclusion bodies, in the cytoplasm of infected cells [28]. Based upon this information CVMV was listed as a putative pararetrovirus and a candidate member of the caulimovirus subgroup [23]. Recently the molecular characterization of the CVMV genome reported by Calvert *et al.* [10] showed an atypical genomic organization distinct from other characterized plant pararetroviruses [12]. The CVMV genome is 8158 nucleotides long and is organized in five open reading frames. Consensus sequences for coat protein, movement protein and replicase have been identified and support the classification of CVMV as a plant pararetrovirus. However,

the putative coat protein domain is located upstream of the putative movement protein sequence in the same ORF, suggesting that they are transcribed as a polyprotein. This particular organization is unusual for both caulimoviruses and badnaviruses [32], the two pararetrovirus subgroups.

Several transcriptional promoters which are capable of causing high levels of gene expression in transgenic plants have been isolated from pararetrovirus genomes [8, 34, 37, 46]. During virus infection, these promoters direct the synthesis of genome-length RNAs which serve as templates for the reverse-transcriptase and as messenger RNAs for synthesis of viral proteins. The 35S promoter from the cauliflower mosaic virus (CaMV) has been widely used in chimeric gene constructs and is well characterized [4, 15, 37, 39]. Synergistic and additive interactions amongst the different *cis* elements upstream of the TATA box combine to confer a constitutive pattern of expression [5, 6, 7]. The 34S promoter from another caulimovirus, the fig-



Fonds Documentaire ORSTOM  
Cote : B \* 7740 Ex. 1

wort mosaic virus (FMV), is also constitutively active in transgenic plants and has been reported to be functionally analogous to the 35S promoter [46]. Promoters isolated from badnaviruses, unlike caulimovirus promoters, seem to be primarily active in vascular tissues. Indeed, it has been reported that the rice tungro bacilliform virus (RTBV) and *Commelina* yellow mottle virus (CoYMV) promoters direct phloem-specific gene expression in transgenic plants [8, 34, 51].

The present study was undertaken to identify the promoter region of the cassava vein mosaic virus and to determine its ability to promote gene expression in transgenic plants. Furthermore, we wanted to analyze the properties of the promoter of this atypical caulimovirus in comparison with those of others promoters isolated from plant pararetroviruses. In this report we describe the isolation of two CVMV promoter fragments and provide evidence of promoter activity using *uidA* gene fusion constructs. The strength of these promoters was evaluated in electroporated protoplasts of cassava and tobacco cell suspension cultures and the pattern of expression was characterized in stably transformed rice and tobacco plants. Evidence of promoter activity in cassava plants was provided by microbombardment of *in vitro* plantlets.

## Materials and methods

### Isolation of promoter fragments and plasmid constructions

Molecular techniques were carried out essentially as described by Sambrook *et al.* [44]. Nucleotide numbers refer to the cassava vein mosaic virus genome nucleotide sequence reported by Calvert *et al.* [10] as concurrently determined in this laboratory (unpublished). The original CVMV full length genomic clone was provided by Dr R.J. Shepherd (University of Kentucky). The clone was constructed by ligating the viral DNA cut at a unique *Bgl*III site to the *Bgl*III site of the plasmid pCKIZ [1]. Restriction fragments derived directly from the genomic clone were cloned into pUC119 plasmid. Using these subclones, two viral DNA fragments containing a consensus TATA box motif were isolated (Fig. 1). A fragment designated CVP1 encompassed CVMV nucleotides 7235 to 7623 and was obtained by *Alu*I enzymatic digestion. A larger fragment containing CVMV nucleotides 7160 to 7675 and designated CVP2, was isolated by PCR amplification. The two oligonuc-

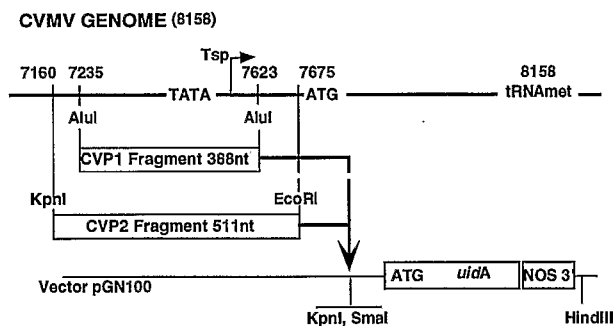

Figure 1. Construction of *uidA* fusion genes. Positions of the promoter fragments are numbered in the CVMV genomic DNA. The CVP1 fragment was isolated using *Alu*I restriction sites while the CVP2 fragment, which included an additional 75 nucleotides at the 5' end and 52 nucleotides at the 3' end, was obtained by PCR amplification using appropriate primers (see Materials and methods for details). The 3' end of CVP2 is just upstream of the first ATG codon in the viral genome. The transcription start site and the position of the consensus tRNA binding site are also indicated. This chart is not drawn to scale. (Tsp, transcription start site)

leotides used in the PCR reaction were: primer 1, 5'-ACCGGTACCAGAAGGTAATTATCCAAGATGT-3' (CVMV sequence from 7160 to 7183 with the addition of a *Kpn*I restriction site at the 5' end) and primer 2, 5'-CGGAATTCAAACCTTACAAATTTCTCTGAAG-3' (CVMV sequence complementary to nucleotides 7675 to 7652 with the addition of an *Eco*RI restriction site at the 5' end). The amplification reaction contained 25 pmol of each primer, 200  $\mu$ M each dNTP, 100 ng of plasmid DNA containing the sequence to be amplified, 2.5 U *Pfu* polymerase and the appropriate buffer (Stratagene). Initial denaturation was performed at 94  $^{\circ}$ C for 5 min then the reaction mixture was denatured at 94  $^{\circ}$ C for 1 min, annealed at 60  $^{\circ}$ C for 1 min and elongated at 72  $^{\circ}$ C for 1 min for each of 15 cycles. Final extension was carried out for 5 min at 72  $^{\circ}$ C. Sequence accuracy of the amplification product was subsequently confirmed by dideoxynucleotide chain-termination sequencing (Sequenase - USB).

Plasmid pILTAB:CVP1 (Fig. 1) was constructed by ligating the *Alu*I CVP1 fragment into *Sma*I site of pGN100, a pUC 119 derived plasmid containing the *uidA*-coding sequence linked to the 3' polyadenylation signal of the nopaline synthase gene (nos 3'). The CVP2 fragment obtained from the PCR reaction was digested by *Kpn*I/*Eco*RI and subsequently blunted at the *Eco*RI 3' end using DNA polymerase I large (Klenow) fragment. The resulting fragment was cloned in *Kpn*I/*Sma*I of pGN100 to obtain pILTAB:CVP2 plasmid (Fig. 1). The cas-

settes containing the CVMV promoter:*uidA* fusion genes were excised by *KpnI/HindIII* digestion from pILTAB:CVP1 and pILTAB:CVP2 and subcloned at *KpnI/HindIII* sites in the pBIN19 binary vector (Clontech) used for *Agrobacterium*-mediated plant transformation. The plasmid pe35GN contains the enhanced 35S promoter [26] and the *uidA* coding sequence linked to the nos 3' end. The plasmid pDO432 contains the luciferase coding sequence from *Photinus pyralis* under the control of the 35S promoter [40]. Plasmids pILTAB:CVP1, pILTAB:CVP2 and pe35GN used in transient assay experiments are each ca. 5.5 kb in size.

#### Plant transformation

Gene constructs containing pBIN19 plasmids were introduced into *Agrobacterium tumefaciens* strain LBA4404 by electroporation [47]. The transformed *Agrobacterium* were used to infect *Nicotiana tabacum* cv. Xanthi NN leaf discs, according to the procedure described by Horsch *et al.* [22]. Regenerated kanamycin resistant plants were transferred to soil and grown in a greenhouse. Seven independent transgenic lines containing the CVP1 construct and eight containing the CVP2 construct were produced. Greenhouse grown plants were allowed to self-fertilize and R1 seeds were collected. The R1 seeds were germinated on Murashige and Skoog (MS) medium [36] containing kanamycin 100 mg/l and the seedlings were grown in greenhouse.

Seven transgenic rice lines (*Oryza sativa* L. Taipei 309) were obtained via particle bombardment as described by Li *et al.* [31], using pILTAB:CVP2 in association with pMON410 (Monsanto Co.); the latter carries the gene for resistance to hygromycin.

#### Histochemical localization of $\beta$ -glucuronidase activity

Histochemical analysis of GUS activity was performed essentially as described by Jefferson *et al.* [24]. Small fragments of leaf and stem from primary transformants or R1 progeny were incubated at 37 °C for 4 to 8 hs in reaction buffer containing 1 mM 5-bromo-4-chloro-3-indolyl glucuronide (X-gluc), 100 mM sodium phosphate buffer pH 7, 2 mM potassium ferrocyanide and potassium ferricyanide, and 0.1% Triton X-100. Roots and floral organs were incubated in the same medium lacking the cyanide salts and including 0.1% mercaptoethanol to reduce tissue browning. Hand-cut tissue sec-

tions were taken and cleared in 70% ethanol. Stained sections were visualized in a Zeiss microscope.

#### RNA preparation and primer extension analysis

Total RNA was extracted from young leaves of transgenic tobacco plants as described by Prescott and Martin [41], with minor modifications. An additional phenol/chloroform extraction was performed, followed by three successive LiCl precipitations.

Primer extension was performed with a 34 bp long oligonucleotide with the sequence 5'-CGCGATCCAGACTGAATGCCACAGGCCGTCGAG-3' which is complementary to a region 34 nucleotides downstream of the ATG start codon in the *uidA* gene. The oligonucleotide (20 pmol) was 5' end-labeled using 6 U of T4 polynucleotide kinase (USB) and 7  $\mu$ Ci of [ $\gamma$ - $^{32}$ P]ATP (3000  $\mu$ Ci/mmol, 10  $\mu$ Ci/ $\mu$ l). After the labeling reaction, the primer was purified using Nucrap Push columns (Stratagene). One-tenth pmol of the labeled primer was mixed with 50  $\mu$ g of total RNA from transgenic plants. The experiment was performed according to Sambrook *et al.* [44] except that annealing was carried out at 30 °C or 40 °C for 12 h, and the extension reaction was allowed to proceed for 1 h at 42 °C with 20 U of AMV reverse transcriptase (Gibco-BRL). The extension products were separated on a 7.5% polyacrylamide gel containing 7 M urea. Sequence reactions (Sequenase-USB) performed with the same labeled primer were subjected to electrophoresis in adjacent lanes on the same gel.

#### Protoplast isolation, treatment and culture

Tobacco protoplasts were isolated from BY-2 (*Nicotiana tabacum* L, cv. Bright Yellow) cell suspension cultures and transfected with DNA essentially as described by Kikkawa *et al.* [27]. Cassava protoplasts were prepared from *Manihot esculenta* L. cv. TMS60444 embryogenic cell suspension cultures [48]. Fifty ml of a 10-day-old culture were collected for protoplast isolation. Prior to enzymatic digestion, the cells were resuspended in 30 ml of medium containing 0.55 M mannitol, 3.2 g/l Schenk and Hilderbrandt salts (Sigma), 1 $\times$  Murashige and Skoog vitamins (Sigma), 20 mM CaCl<sub>2</sub>, pH 5.8 (medium A). The cells were allowed to settle and medium A was replaced by an enzymatic solution consisting of medium A supplemented by 2% cellulase Onozuka RS and 0.1% Pectolyase Y 23. Digestion was performed in the dark for 3.5 h at 27 °C. Cells were gently agitated during the first

hour of treatment. The incubation mixture was filtered sequentially through sieves of 100  $\mu\text{m}$  and 70  $\mu\text{m}$ . Protoplasts were washed three times by centrifugation at  $100 \times g$  for 10 min in medium A. The number of protoplasts was estimated using a hemocytometer.

The purified protoplasts were resuspended to final density of  $10^6$  cells/ml in electroporation buffer containing 5 mM MES, 130 mM NaCl, 10 mM  $\text{CaCl}_2$ , 0.45 M mannitol pH 5.8. Two hundred  $\mu\text{l}$  of electroporation buffer containing 30  $\mu\text{g}$  of each plasmid was added to 800  $\mu\text{l}$  of protoplast suspension in a 0.4 cm path-length cuvette. DNA uptake was carried out using a Gene Pulser instrument (BioRad) delivering a 300 V pulse at a capacitance of 500  $\mu\text{F}$ . After electroporation, the protoplasts were incubated in ice for 30 min, after which they were resuspended at a density of  $10^5$  cell/ml in culture medium A supplemented with 20% sucrose and  $5 \times 10^{-5}$  M Pichloran. After 24 h of incubation in the dark at 27 °C, the protoplasts were collected by centrifugation (10 min at  $100 \times g$ ) and resuspended in GUS extraction buffer [24], pH 7.7.

#### *LUC and MUG assays*

Transfected protoplasts were lysed by vortexing for 2 min in GUS extraction buffer, pH 7.7. Extracts were clarified by centrifugation ( $5000 \times g$ , 5 min) at 4 °C in a microcentrifuge. The supernatant was recovered and used for MUG and LUC assays. GUS activity was determined using 4-methyl-umbelliferyl- $\beta$ -D-glucuronide (MUG-Sigma) by the method of Jefferson [24] and quantified for 50  $\mu\text{l}$  of extract as pmol methylumbelliferone (MU) per hour. LUC activity was determined on 50  $\mu\text{l}$  of the same protein extract with a luminometer (Monolight 2010) using a luciferase assay (Analytical Luminescence Laboratory, San Diego, CA). Cotransfection of cells with a *uidA* gene plus a luciferase plasmid allowed us to normalize variations of GUS activity between experiments [30]. The normalized GUS data were expressed as pmol methylumbelliferone (MU) per hour per unit of light emitted.

Transgenic plant tissues were ground in GUS buffer, pH 8, and GUS activity was evaluated as described [24]. The enzyme activity (pmol/min) was referred to mg protein as determined by the dye-binding method of Bradford [9].

#### *Particle bombardment*

Leaves and stems were cut from cassava plantlets (cultivar Mcol 1505) grown *in vitro* on medium containing MS salts and vitamins, sucrose 20 g/l,  $\text{CuSO}_4$  2  $\mu\text{M}$ , Phytigel 3 g/l, pH 5.7. The explants were sectioned and the tissue fragments were subsequently arranged in the center of 9 cm Petri dishes containing solidified culture medium. Micro-bombardment was performed with an helium-driven particle delivery system (PDS 1000/He-BioRad). Preparation of gold particles (average diameter 1.6  $\mu\text{m}$ ) and coating particles with DNA were carried out essentially as described by the instruction manual (BioRad). The target plates were placed in the gun chamber at the third level from the bottom while the assembly macrocarrier/stopping screen was placed at the fifth level. Each plate was shot twice at a pressure of 1100 PSI with ca. 1  $\mu\text{g}$  of plasmid DNA. After bombardment, sterile water was added to the plates to prevent desiccation of the material. Explants were incubated 2 days in the dark at 25 °C prior to histochemical GUS assays.

## Results

#### *Isolation of the CVMV promoter*

A genomic clone of cassava vein mosaic virus (CVMV) was kindly provided by Dr R. J. Shepherd (University of Kentucky) for these studies. Sequence analysis of the CVMV clone allowed us to identify in the viral genome, an AT rich region similar to that of the plant pararetroviruses TATA box regions (Fig. 2A). The putative TATA box region is located 588 nucleotides upstream of another consensus sequence that is complementary to the 3' end of a plant tRNA<sup>met</sup>; this sequence is present in all plant pararetroviruses and serves as a primer binding site to initiate the viral replication process [21]. The location of the putative TATA box sequence in CVMV is similar to the promoters that control the transcription of the genome length transcripts in CaMV [18], FMV [43] and RTBV [20, 42].

This information allowed us to predict the location of a putative promoter in the CVMV genome. Two DNA fragments were subsequently isolated and tested for promoter expression: CVP1 comprising 387 nucleotides from position -368 to +20 (+1 corresponds to the transcription start site reported in this paper), and CVP2, a fragment of 514 nucleotides

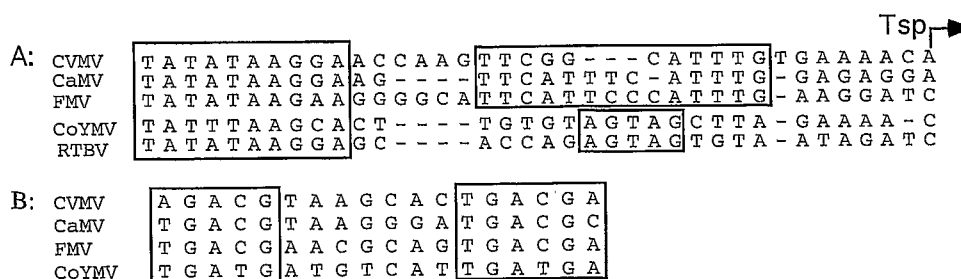

Figure 2. Conserved nucleotide motifs in plant pararetrovirus promoters. A. Comparison of nucleotide sequences from the TATA box to the transcription start site of promoters from plant pararetroviruses [2, 19, 33, 45]. Regions of high homology are framed. Tsp indicates the transcription start point of these promoters. B. Sequence alignment of different as1 like elements found in the CaMV, FMV, CoYMV and CVMV promoter. CaMV and FMV have been characterized as caulimoviruses [18, 43] whereas CoYMV and RTBV are badnaviruses [33, 42].

from position -443 to +72 (Fig. 1). Both fragments were cloned into a plasmid that contains the *uidA*-coding sequence for analysis of promoter activity. The nucleotide sequences of the promoter fragments are presented in Fig. 3 and were confirmed by the results reported by Calvert *et al.* [10]. A comparison with other pararetrovirus promoter sequences, namely the 35S CaMV [18], the 34S FMV [43], RTBV [42], and CoYMV [33] promoters revealed the presence of a conserved TATA box as mentioned previously, and a 17 nucleotide motif AGACGTAAGCACTGACG (position -203 to -219) that has strong homology with the transcriptional enhancer as1 found in the 35S CaMV, FMV, and CoYMV promoters (Fig. 2B). We also identified a 22 nucleotide sequence CTTATCACAAAGGAATCTTATC (position -90 to -111) that is present in the CoYMV promoter but not in RTBV or caulimovirus promoters. This limited homology suggested that we had isolated a distinct plant pararetrovirus promoter.

#### Determination of the transcription start site

The transcription start site of the CVMV promoter was determined by primer extension analysis using total RNA recovered from transgenic tobacco plants which harbored the CVP1: *uidA* fusion gene (Fig. 1). A single major extension product was detected and mapped to an adenine residue (nt 7604) located 35 nucleotides downstream of the putative TATA box (Fig. 4). By comparison with the location of the start of transcription reported for other plant pararetrovirus promoters [2, 19, 33, 45] (Fig. 2A), the transcription start site reported here likely represents the 5' end of the CVMV transcript. By comparing sequence of the CVMV promoter from the TATA box to the start of transcrip-

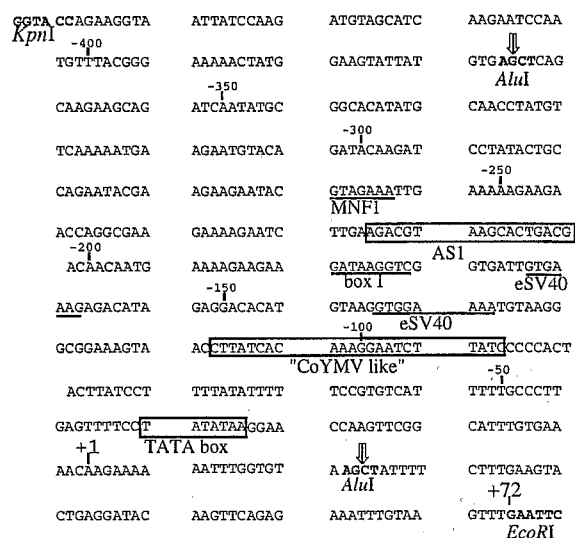
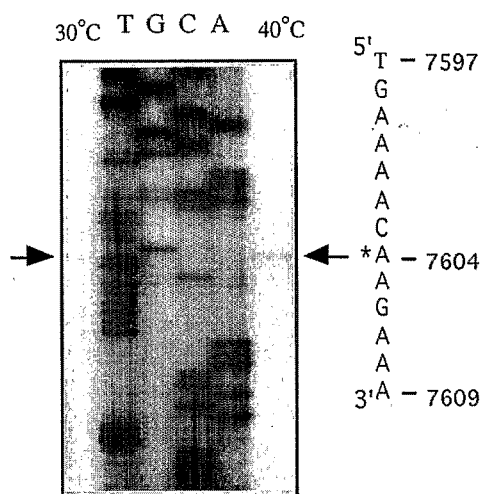

Figure 3. Nucleotide sequence of CVP1 and CVP2 promoter fragments. The transcription start site is designated +1. Consensus TATA box, as 1-like sequence [29] and the region homologous with the CoYMV promoter [35] are boxed. *AluI* sites (↓) indicate the 5' and 3' ends of the CVP1 promoter. Sequence motifs similar to previously characterized *cis* elements in plant promoters are underlined (motifs with similarities with the box I element [13] of the *rbcS* promoter, MNF1-binding site [50], SV40 core enhancer [38] are indicated).

tion with those of caulimovirus promoters FMV 34S and CaMV 35S, we concluded that these three promoters are, in this region, closely related to each other (Fig. 2A). In contrast there is less homology with the promoters from badnaviruses (CoYMV and RTBV).

#### Expression of the CVMV promoter in protoplasts

Promoter fragments CVP1 and CVP2 were tested in transient assay experiments using tobacco and cassava protoplasts obtained from cell suspension cultures. We



**Figure 4.** Determination of the transcription start site of the CVMV promoter. Primer extension reactions were carried out as described in Materials and methods. The products of the extension reactions, obtained with two annealing temperatures (30 °C and 40 °C) and reference sequencing reactions of CVP1-*uidA* gene construct (lanes A, C, G and T) performed with the same labeled primer, were subjected to electrophoresis in a 7 M urea, 7.5% polyacrylamide gel. The plus strand DNA sequence (complementary to the sequence read on the gel) is shown and the transcription start site (A\*) is indicated by an arrow. Numbers correspond to the nucleotide sequence numbers of the CVMV genome [10].

used in this experiment, the plasmids pILTAB:CVP1 and pILTAB:CVP2. The plasmid pe35GN, containing the *uidA* sequence under the control of the enhanced 35S promoter (e35S) [26], served as a positive control. Each plasmid was co-introduced into protoplasts with a plasmid containing a luciferase gene under the control of the CaMV 35S promoter [40]. The GUS/LUC ratio was determined after each transfection experiment. Four independent transfection experiments, summarized in Fig. 5, were carried out and gave similar results. In tobacco protoplasts the GUS/LUC ratio for the CVP1 promoter was 0.58, or about 50% of the level of expression determined by the e35S promoter (1.32). However, when the CVP2 fragment was used, the ratio was 1.3, or two-fold more active than CVP1. The difference between the two fragments indicated that CVP1 lacks one or more important element(s) for high level expression. CVP2 and e35S promoters yielded similar GUS activity indicating that the CVMV promoter is a strong promoter in tobacco protoplasts. Similar studies in cassava protoplasts gave results comparable to those in tobacco showing that the CVMV promoter is also very effective in these cells.

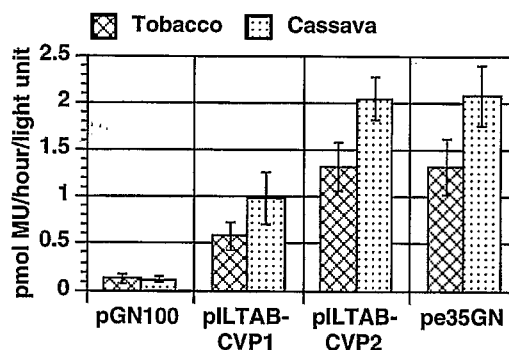

**Figure 5.** Expression of the CVMV promoters in tobacco and cassava protoplasts. Chimeric *uidA* gene constructs were co-introduced with a plasmid to express luciferase [40] into protoplasts of cassava and tobacco via electroporation. Promoter activity is expressed as a ratio between GUS activity and LUC activity of the same protein extract. As a consequence, GUS activity is measured as pmol 4-methylumbelliferyl- $\beta$ -D-glucuronide (MUG) per hour per unit of light emitted. Bars represent the average of four independent experiments  $\pm$  standard errors. Each experiment was carried out with a different protoplast preparation. pe35GN is a construct where the enhanced 35S promoter [26] controls the transcription of the *uidA* gene. pGN100 contains a promoter-less *uidA* gene.

#### *Expression of the CVMV promoter in transgenic tobacco and rice plants*

Seven transformed tobacco lines containing CVP1 promoter-*uidA* fusion gene and eight containing CVP2 promoter were obtained as described in Materials and methods. Presence of the full length gene cassette was confirmed by PCR analysis (data not shown) of primary transformants (plants regenerated from transgenic calli). A detailed histochemical analysis of GUS accumulation was carried out using hand-cut fresh tissue sections of various organs from primary transformed plants and their R1 progeny. All transformed tobacco plants containing either the CVP1 or CVP2 fragment had essentially the same gene expression pattern while intensity of staining varied among transformants. In leaves, strong GUS activity was observed in phloem tissues in the midrib and in the lateral secondary veins (Fig. 6A, B). Parenchyma cells adjacent to xylary elements also developed a blue staining pattern while the parenchyma cells of the midrib did not contain detectable GUS activity (Fig. 6A, B) except for the chlorenchyma cells just below the epidermis (Fig. 6C). The cells of the palisade layer and the spongy mesophyll in the leaf lamina exhibited a very intense staining (Fig. 6A, C), while in the epidermis, guard cells and trichomes, especially the glandular tip cell, developed an intense staining. Non-specialized

epidermal cells accumulated little or no stain. Cross sections of stems showed strong staining of the phloem cells, including internal phloem bundles located in the central pith tissue and phloem cells located external to the xylem (Fig. 6D). Weaker expression was also visible in the xylem parenchyma cells. GUS staining was not detectable in pith cells or in cortical parenchyma cells of the stem (Fig. 6D). Root tissues incubated with X-Gluc revealed a blue stained vascular cylinder (Fig. 6E); cross-sections were not taken due to the fragile nature of the tissue. The root tips stained the most intensely of any region in the root (Fig. 6E). In the flowers, the basal part of the ovary exhibited an intense blue staining. The vascular elements of floral tissue displayed a strong staining in the stamen, the style and the placenta inside the ovary (Fig. 6F), as well as in the sepals and petals. Pollen also exhibited a blue color (not shown). R1 seedlings developed the same general pattern of staining as did the R0 parental transformant except that GUS activity in the mesophyll of cotyledons appear weaker than in mature leaves.

Histochemical analysis to detect GUS activity was performed in a similar manner on 7 independently transformed rice lines that harbored the CVP2: *uidA* gene. The general expression pattern of the CVP2 promoter-*uidA* gene was quite similar in rice and tobacco, despite the differences in anatomy of these plants. Transverse sections of leaves incubated with X-Gluc substrate resulted in strong staining in the vascular bundles and in the mesophyll cells (Fig. 6G). The small phloem parenchyma cells and the xylem parenchyma cells exhibited an intense staining while the metaxylem tracheary elements and the larger sieve elements appeared to be free of any blue precipitate. Bundle sheath cells, bulliform cells and sclerenchyma fibers also showed no staining. Guard cells and leaf hair cells were stained in the leaf epidermis. The pattern of GUS activity revealed in cross-sections of the leaf sheath tissue (Fig. 6H) was similar with that observed in leaves. As observed in tobacco plants, GUS activity was not detectable in parenchyma cells (Fig. 6H). Roots were stained only in the vascular cylinder and in the tip. Rice floral tissue had essentially the same pattern of GUS activity as the tobacco flowers (Fig. 6I).

GUS activity in extracts prepared from different organs was determined among tobacco and rice transformed plants using the 4-methylumbelliferyl- $\beta$ -D-glucuronide (MUG) fluorescence assay [24]. The organs tested included young leaves, mature leaves, stem and root (Fig. 7). This experiment showed that the CVMV promoter (CVP1 and CVP2 constructs) is

expressed in all organs of transformed rice and tobacco. These results supported the GUS histochemical analysis of transgenic plant presented previously, and confirmed the constitutive property of the cassava vein mosaic virus promoter. We observed that the CVMV promoter was more active in leaves than in others organs while the lowest level of expression was in roots. The GUS expression levels, measured for the rice leaf sheath, were very close to those measured in leaves. This could be due to the presence of photosynthetic mesophyll tissue at the periphery of rice leaf sheath (see Fig. 6H for anatomic detail). In tobacco, GUS expression in the plants harboring the CVP2 promoter construct appeared slightly stronger than in plants containing the CVP1 promoter. However, this result has to be confirmed by more extended analysis, due to the relative low number of lines tested and to the variation observed in the transgene expression between lines. The latter could be due to a putative position effect or/and to the different copy number of the inserted gene.

#### *Activity of the CVMV promoter in cassava plant explants*

The promoter activity of the CVP2 fragment (Fig. 1) was tested in cassava plants by micro-particle bombardment on stem and leaf explants from material grown *in vitro*. The plasmid pILTAB:CVP2 and plasmid p35GN (as positive control) were used in this study. Approximately the same number of intensely blue-stained foci showing GUS expression (Fig. 6J) were found using plasmids containing either promoter. Blue-stained cells were found in epidermal cells, guard cells, mesophyll cells and along the veins of leaflets. These experiments provided evidence of promoter activity for CVP2 fragments in different cell types of cassava.

#### **Discussion**

We have isolated a promoter from the viral genome of the newly characterized cassava vein mosaic virus [10]. The transcription start site of the promoter was determined using RNA isolated from transgenic plants that contain the pCVMV-*uidA* gene. Our results indicate that the CVMV promoter is strong in tobacco and cassava protoplasts and its activity is similar to that obtained with the e35S promoter. Of the two promoter fragments tested in protoplasts, the shorter frag-

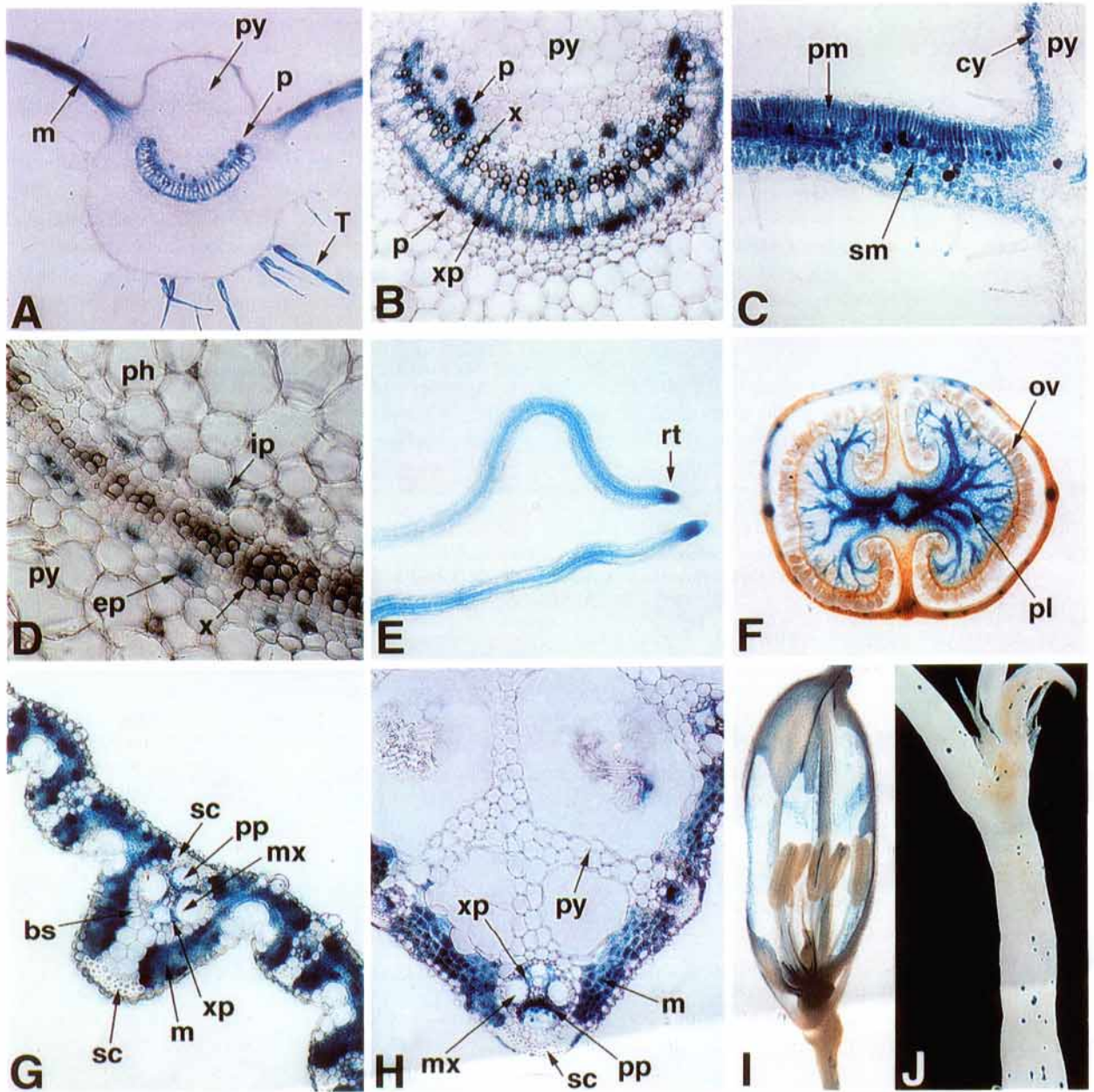

**Figure 6.** Histochemical localization of GUS expression in transgenic tobacco and rice plants containing CVMV promoter-*uidA* gene fusion. GUS activity is indicated in the transgenic tissues by an indigo dye precipitate after staining with X-Gluc. Pictures presented are from CVP2:*uidA* transgenic plants. A. Tobacco leaf section. B. Detail of tobacco leaf section showing vascular tissues of the midrib ( $\times 10$ ). C. Transverse section through tobacco leaf lamina ( $\times 30$ ). D. Vascular tissues in tobacco stem cross-section ( $\times 30$ ). E. Tobacco roots ( $\times 10$ ). F. Transverse section through tobacco ovary ( $\times 10$ ). G. Rice leaf cross-section ( $\times 50$ ). H. Cross-section of a rice leaf sheath ( $\times 50$ ). I. Rice flower split axially and subsequently stained for GUS activity ( $\times 10$ ). J. GUS transient expression on cassava stem from *in vitro* plantlet ( $\times 5$ ). bs, bundle sheath; cy, chlorenchyma; ep, external phloem; ip, internal phloem; m, mesophyll; mx, metaxylem; ov, ovule; p, phloem; ph, pith; pl, placenta; pm, palisade mesophyll; pp, phloem parenchyma; py, parenchyma; rt, root tip; sc, sclerenchyma; sm, spongy mesophyll; x, xylem; xp, xylem parenchyma.



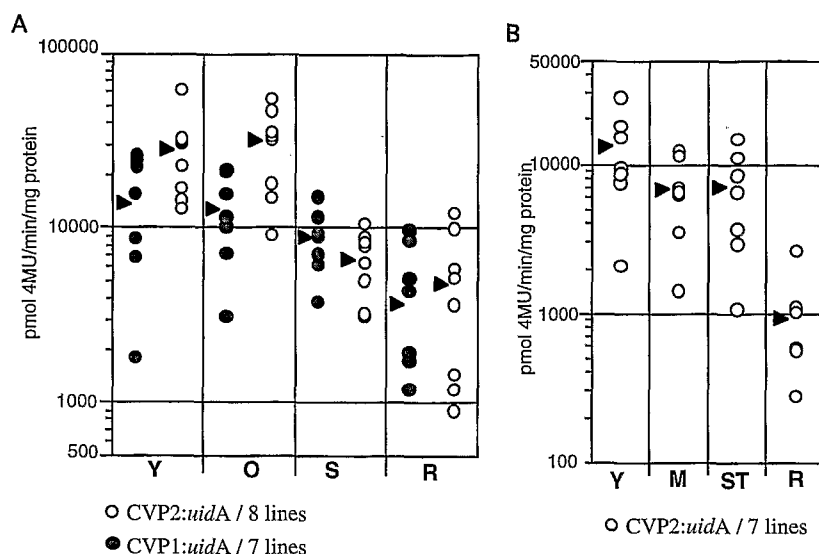

**Figure 7.** Distribution of GUS activity in different tissues among tobacco (A) and rice (B) transgenic lines. Specific GUS activity is given as picomoles of 4 methylumbelliferone per milligram of protein per minute. Transgenic tobacco lines containing either CVP1 (solid dots) or CVP2 (open dots): *uidA* fusion gene were tested for GUS activity in young leaves (Y / 3 to 5 cm in length), mature leaves (M / 10 cm and up in length), stems (S), and roots (R). Transgenic rice lines tested contained only the CVP2 construct. Samples for protein extraction were taken from mature (5 to 7 weeks old) R1 transgenic tobacco plants grown in a greenhouse. Rice plants used in this study were R0 transformants (2 months old) grown in a greenhouse. In rice, ST refers to leaf sheath explants. Distribution of GUS activity was plotted and is shown for tobacco (panel A) and rice (panel B) plants. Each dot represents a single independent transgenic line. Number of lines tested is mentioned on the figure. Mean level of GUS activity in the different organs and for each construct is indicated by a solid arrow. Logarithmic scale was used to accommodate large variation between lines.

ment CVP1 is approximately two-fold less active than the longer CVP2 fragment. However, both fragments result in the same pattern of expression in transgenic tobacco and plants. Differences in the level of expression observed in protoplasts could be due to a transcriptional enhancer in the 5' region of the larger fragment or to the larger untranslated leader sequence. The latter could be important for greater message stability or translation efficiency. The first 60 nucleotides of the CaMV leader (from +1 to the first ATG) stimulate expression of a downstream gene by about 2-fold [14, 17]. Similar effect has been reported for the untranslated leader of the rice tungro bacilliform virus promoter [11]. However there is limited sequence homology between the CVMV leader and those of the CaMV or RTBV leaders. Analysis of transgenic plants indicate that the CVMV promoter, as is the case with other caulimovirus promoters, is active in all organs, in various cell types and is not dependent on viral trans-acting factors. The CVMV promoter is strongly expressed in vascular tissues, in leaf mesophyll cells, and in the root tips of rice and tobacco plants. However, GUS activity was non detectable in non-chlorophyllaceous cells of tobacco pith and cortical parenchyma. This

could indicate that the CVMV promoter has two major domains of activity, i.e., the vascular elements and the green, chloroplast-containing cells. Analysis of CaMV 35S-*uidA* gene expression in transgenic tobacco and rice plants (not shown) confirmed previous reports [3, 24, 49] and also showed more staining in chlorophyllaceous cells than in cortical parenchyma cells. However, we cannot exclude the possibility that these observations are due to the limitations of the staining assay. Large cells with little cytoplasm (such as parenchyma cells) may appear to contain little or no stain compared with smaller cells with dense cytoplasm. Likewise, cells with different metabolic activities may stain with different intensities.

This study has shown that expression of the CVMV promoter in protoplasts and transgenic plants is relatively similar to that of the 35S promoter. However, the nucleotide sequence of the CVMV promoter has limited homologies with other caulimovirus promoters which may imply differences in the mechanisms of regulation of the promoter. Analysis of the CVMV promoter sequence shows the presence of several motifs that resemble previously identified *cis* elements that are implicated in transcriptional regulation. The pres-

ence of such motifs in the CVMV promoter could explain the pattern of expression in transgenic plants. A 16 bp motif with strong homology with the activation sequence 1 (as1) of the CaMV 35S promoter [29] was identified in the CVMV promoter at nt -203 to -219. This motif is also found in the FMV promoter [46]. A less conserved motif has also been identified in the CoYMV badnavirus promoter [34]. The as1 element, characterized by TGACG direct repeats, binds to the AS1 nuclear factor [16] as well as the cloned TGA1 transcription factor [25]. This motif, in the CaMV 35S promoter, is able to confer expression principally in root tissues [4], but it also plays a more complex role in the regulation of the promoter by interacting synergistically with other *cis*-elements [15, 29]. However, in the CVMV promoter, this as1 motif is located at position -203 to -219 while in the caulimovirus promoters, it is generally closer to the TATA box (-83 to -63 in the 35S CaMV promoter; -57 to -73 in the FMV promoter).

At position -90 to -111 we identified a 22 nucleotide sequence CTTATCACAAAGGAATCTTATC that is present at the same relative position (-78 to -100) in the CoYMV promoter but not in other plant pararetrovirus promoters. This motif is located in the CoYMV promoter in a region required for expression in vascular tissues [35]. The CVMV promoter also includes the motif AAGATAAGG (-186 to -194) which contains the boxI consensus GATAAG that is present in *rbcS* gene promoters [13]. In addition, the sequence GTAGAAA, identified at position -257 -263, is identical to the binding site sequence for the MNF1 leaf-specific nuclear factor, found in the PEPc gene promoter as well as in the 35S promoter [50]. These motifs could be involved in the strong gene expression of the CVMV promoters in mesophyll cells. Nucleotides -170 to -130 (Fig. 2) contain two motifs that are similar to the SV 40 enhancer core sequence GTGGAAAG [38]. The relative importance and the biological role of all these motifs in this promoter are being evaluated.

### Acknowledgements

The authors are grateful to Dr R. J. Shepherd (University of Kentucky) for providing us with the CVMV genomic clone. We also thank Dr D.R. Helinski (University of California, San Diego) for the generous gift of the plasmid pDO432. We wish to acknowledge C. Fux, S.L. Leitner and L. Chen for great assistance in

plant transformation and plant maintenance. We would also like to thank Professor A.M. Boudet (University Paul Sabatier, Toulouse, France) for his advice and suggestions. This work was supported by the Rockefeller Foundation and the French Institute for Development by Cooperation (ORSTOM).

### References

1. Anza OA: Replication and mapping of caulimoviruses. PhD thesis, University of California, Davis, CA (1982).
2. Bao Y, Hull R: Mapping the 5'-terminus of rice tungro bacilliform viral genomic RNA. *Virology* 197: 445-448 (1993).
3. Battraw M, Hall T: Histochemical analysis of CaMV promoter- $\beta$ -glucuronidase gene expression in transgenic rice plants. *Plant Mol Biol* 15: 527-538 (1990).
4. Benfey PN, Chua NH: The CaMV 35S enhancer contains at least two domains which can confer different developmental and tissue specific expression patterns. *EMBO J* 8: 2195-2202 (1989).
5. Benfey PN, Chua NH: The cauliflower mosaic virus 35S promoter: combinatorial regulation of transcription in plants. *Science* 250: 959-966 (1990).
6. Benfey PN, Ren L, Chua NH: Combinatorial and synergistic properties of CaMV 35S enhancer subdomains. *EMBO J* 9: 1685-1696 (1990).
7. Benfey PN, Ren L, Chua NH: Tissue-specific expression from CaMV 35S enhancer subdomains in early stages of plant development. *EMBO J* 9: 1677-1684 (1990).
8. Bhattacharyya-Pakrasi M, Peng J, Elmer JS, Laco G, Shen P, Kaniewska MB, Kononowicz H, Wen F, Hodges TK, Beachy RN: Specificity of a promoter from the rice tungro bacilliform virus for expression in phloem tissues. *Plant J* 4: 71-79 (1993).
9. Bradford MM: a rapid and sensitive method for the quantification of microgram quantities of protein utilizing the principle of protein dye-binding. *Anal. Biochem* 72: 248-254 (1976).
10. Calvert L, Ospina M, Shepherd RJ: Characterization of cassava vein mosaic virus: a distinct plant pararetrovirus. *J Gen Virol* 76: 1271-1276 (1995).
11. Chen G, Müller M, Potrykus I, Hohn T, Fütterer J: Rice tungro bacilliform virus: transcription and translation in protoplasts. *Virology* 204: 91-100 (1994).
12. Covey S, Hull R: Genetic engineering with double-stranded DNA viruses. In: Wilson TMA, Davies JWG (eds) *Genetic Engineering with Plant Viruses*, pp. 217-221. CRC Press, Boca Raton, FL (1992).
13. Donald G, Cashmore A: Mutation of either G box or I box sequences profoundly affects expression from the *Arabidopsis rbcS-1A* promoter. *EMBO J* 9: 1717-1726 (1990).
14. Dowson J, Ashurst JL, Mathias SL, Watts JW, Wilson MA, Dixon RA: Plant viral leaders influence expression of a reporter gene in tobacco. *Plant Mol Biol* 23: 97-109 (1993).
15. Fang RX, Nagy F, Sivasubramaniam S, Chua NH: Multiple *cis* regulatory elements for maximal expression of the cauliflower mosaic virus 35S promoter in transgenic plants. *Plant Cell* 1: 141-150 (1989).
16. Fromm H, Katagiri F, Chua NH: An octopine synthase enhancer element directs tissue-specific expression and binds ASF-1, a factor from tobacco nuclear extracts. *Plant Cell* 1: 977-984 (1989).

17. Fütterer J, Gordon K, Sanfaçon H, Bonneville J, Hohn T: Positive and negative control of translation by the leader sequence of cauliflower mosaic virus pregenomic 35S RNA. *EMBO J* 9: 1697-1707 (1990).
18. Gardner RC, Howarth AJ, Hahn P, Brown-Luedi M, Shepherd RJ, Messing J: The complete nucleotide sequence of an infectious clone of cauliflower mosaic virus by M13mp7 shotgun sequencing. *Nucl Acids Res* 9: 2871-2887 (1981).
19. Guillely H, Dudley RK, Jonard G, Balasz E, Richards KE: Transcription of cauliflower mosaic virus DNA: detection of promoter sequences, and characterization of transcripts. *Cell* 30: 763-773 (1982).
20. Hay JM, Matthew CJ, Blakebrough M, Dasgupta I, Davies JW, Hull R: An analysis of the sequence of an infectious clone of rice tungro bacilliform virus, a plant pararetrovirus. *Nucl Acids Res* 19: 2615-2621 (1991).
21. Hohn T, Hohn B, Pfeiffer P: Reverse transcription in CaMV. *Trends Biochem Sci* 10: 205-209 (1985).
22. Horsch RB, Fry J, Hoffmann N, Neidermeyer J, Rogers SG, Fraley RT: Leaf disc transformation. In Gelvin SB, Schilperoort RA (eds) *Plant Molecular Biology Manual*, pp. A5/1-A5/9. Kluwer Academic Publishers, Dordrecht, Netherlands (1988).
23. Hull R: Caulimovirus group. CMI/ABB, Description of plant viruses no. 229 (1984).
24. Jefferson RA, Kavanagh TA, Bevan MW: Gus fusion:  $\beta$ -glucuronidase as a sensitive and versatile gene fusion marker in higher plants. *EMBO J* 6: 3901-3907 (1987).
25. Katagiri F, Seipel K, Chua NH: Identification of a novel dimer stabilization region in a plant bZIP transcription activator. *Mol Cell Biol* 12: 4809-4816 (1992).
26. Kay R, Chan A, Daly M, McPherson J: Duplication of CaMV 35S promoter sequences creates a strong enhancer for plant genes. *Science* 236: 1299-1302 (1987).
27. Kikkawa H, Nagata T, Matsui C, Takebe I: Infection of protoplasts from tobacco suspension culture by tobacco mosaic virus. *J Gen Virol* 63: 457-467 (1982).
28. Kitajima EW, Costa AS: Partículas esféricas associadas ao vírus do mosaico das nervuras da mandioca. *Bragantia* 25: 211-221 (1966).
29. Lam E, Benfey PN, Gilmartin PM, Fang RX, Chua NH: Site-specific mutations alter *in vitro* factor binding and change promoter expression pattern in transgenic plants. *Proc Natl Acad Sci USA* 86: 7890-7894 (1989).
30. Leckie F, Devoto A, De Lorenzo G: Normalization of GUS by luciferase activity from the same cell extract reduces transformation variability. *BioTechniques* 17: 54-57 (1994).
31. Li L, Qu R, de Kochko A, Fauquet C, Beachy R: An improved rice transformation system using the biolistic method. *Plant Cell Rep* 12: 250-255 (1993).
32. Lockart BEL: Evidence for a double-stranded circular DNA genome in a second group of plant viruses. *Phytopathology* 80: 545-550 (1990).
33. Medberry SL, Lockhart BEL, Olszewski NE: Properties of *Commelina* yellow mottle virus's complete DNA sequence, genomic discontinuities and transcript suggest that it is a pararetrovirus. *Nucl Acids Res* 18: 5505-5513 (1990).
34. Medberry SL, Lockhart BEL, Olszewski NE: The *Commelina* yellow mottle virus promoter is a strong promoter in vascular and reproductive tissues. *Plant Cell* 4: 185-192 (1992).
35. Medberry SL, Olszewski NE: Identification of *cis*-elements involved in *Commelina* yellow mottle virus promoter activity. *Plant J*: 619-626 (1993).
36. Murashige T, Skoog F: A revised medium for rapid growth and bioassays with tobacco tissue culture. *Physiol Plant* 15: 473-497 (1962).
37. Odell JT, Nagy F, Chua NH: Identification of DNA sequences required for activity of the cauliflower mosaic virus 35S promoter. *Nature* 313: 810-812 (1985).
38. Ondek B, Shepard A, Herr W: Discrete elements within the SV40 enhancer region display different cell-specific enhancer activities. *EMBO J* 6: 1017-1025 (1987).
39. Ow DW, Jacobs JD, Howell SH: Functional regions of the cauliflower mosaic virus 35S RNA promoter determined by use of the firefly luciferase gene as a reporter of promoter activity. *Proc Natl Acad Sci USA* 84: 4870-4874 (1987).
40. Ow DW, Wood HV, DeLuca M, De Wet JR, Helinski DR, Howell SH: Transient and stable expression of the firefly luciferase gene in plant cells and transgenic plants. *Science* 234: 856-859 (1986).
41. Prescott A, Martin C: A rapid method for the quantitative assessment of levels of specific mRNAs in plants. *Plant Mol Biol Rep* 4: 219-224 (1987).
42. Qu R, Bhattacharyya M, Laco G, De Kochko A, Subba Rao BL, Kaniewska MB, Elmer S, Rochester DE, Smith CE, Beachy RN: Characterization of the genome of rice tungro bacilliform virus: comparison with *Commelina* yellow mottle virus and caulimoviruses. *Virology* 185: 354-364 (1991).
43. Richins RD, Scholthof HB, Shepherd RJ: Sequence of figwort mosaic virus DNA (caulimovirus group). *Nucl Acids Res* 15: 8451-8466 (1987).
44. Sambrook J, Fritsch EF, Maniatis T: *Molecular Cloning: A Laboratory Manual*. Cold Spring Harbor Laboratory Press, Cold Spring Harbor, NY (1989).
45. Sanfaçon H: Analysis of figwort mosaic virus (plant pararetrovirus) polyadenylation signal. *Virology* 198: 39-49 (1994).
46. Sanger M, Daubert S, Goodman RM: Characteristics of a strong promoter from figwort mosaic virus: comparison with the analogous 35S promoter from cauliflower mosaic virus and the regulated mannopine synthase promoter. *Plant Mol Biol* 14: 433-443 (1990).
47. Singh A, Kao TH, Lin JJ: Transformation of *Agrobacterium tumefaciens* with T DNA vector using high-voltage electroporation. *Focus* 15: 84-87 (1993).
48. Taylor NJ, Edwards M, Klerman RJ, Davey C, Blakesley D, Henshaw GG: Development of friable embryogenic callers and embryogenic suspension cultures in cassava (*Manihot esculenta* (rantz). *Nature Biotechnology* 14: 726-730 (1996).
49. Terada R, Shimamoto K: Expression of CaMV35S-GUS gene in transgenic rice plants. *Mol Gen Genet* 220: 389-392 (1990).
50. Yanagisawa S, Katsura I: MNF1, a leaf tissue-specific DNA-binding protein of maize, interacts with the cauliflower mosaic virus 35S promoter as well as the C4 photosynthetic phosphoenolpyruvate carboxylase gene promoter. *Plant Mol Biol* 19: 545-553 (1992).
51. Yin Y, Beachy R: The regulatory regions of the rice tungro bacilliform virus promoter and interacting nuclear factor in rice (*Oryza sativa* L.). *Plant J* 7: 969-980 (1995).